

Blindtex Custom Shutter Specification

2020 Bypass

Effective Date	Remark
2021/01/21	For the louver closed bypass side view drawings: Change the separation of the top tracks (the distance from the front of the header to the center of the 1st top track is 20mm, and from the center of the 1st top track to the center of the 2nd top track is 56mm for Ultra Program.

Blindtex Custom Shutter Specification

2020 Bypass

Track Shutters—Bypass

Guidelines and Specs:

Material: available for all shutter materials.

Stile: 41.3mm, 50.8mm, 57.1mm rabbet and butt stiles are available,
Center stile is not available.

Panel size limitation: same as the normal shutter spec.

Size Definition:

Outside Mount

Max frame-to-frame width: window width + 76mm

Max frame-to-frame height: window height + 114.3mm

Semi-Inside Mount

Max frame-to-frame width: window width – 3.2mm

Max frame-to-frame height: window height + 28.6mm

Inside Mount

Max frame-to-frame width: window width - 3.2mm

Max frame-to-frame height: window height – 3.2mm

Note: 2020 Stopper will be supplied at both ends of top track by default.

Top View

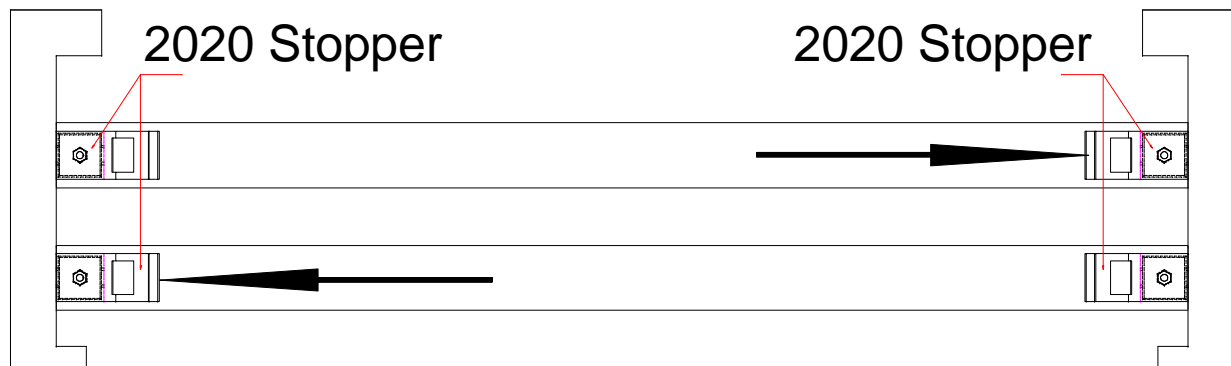

Blindtex Custom Shutter Specification

2020 Bypass

Outside Mount

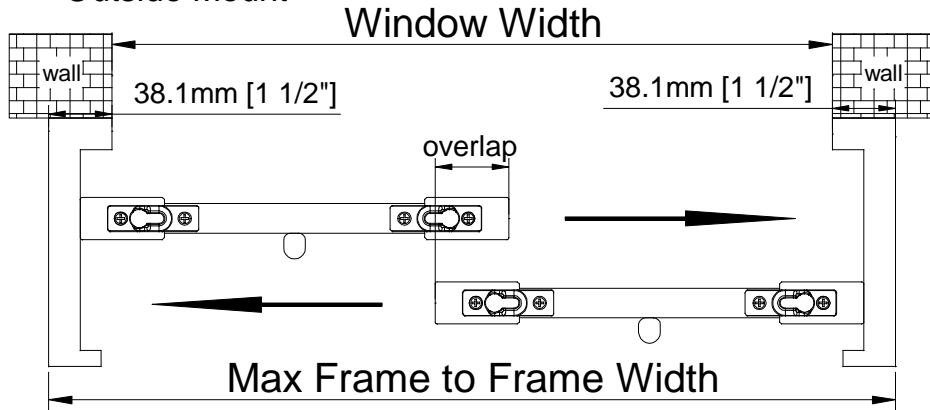

Semi-Inside Mount

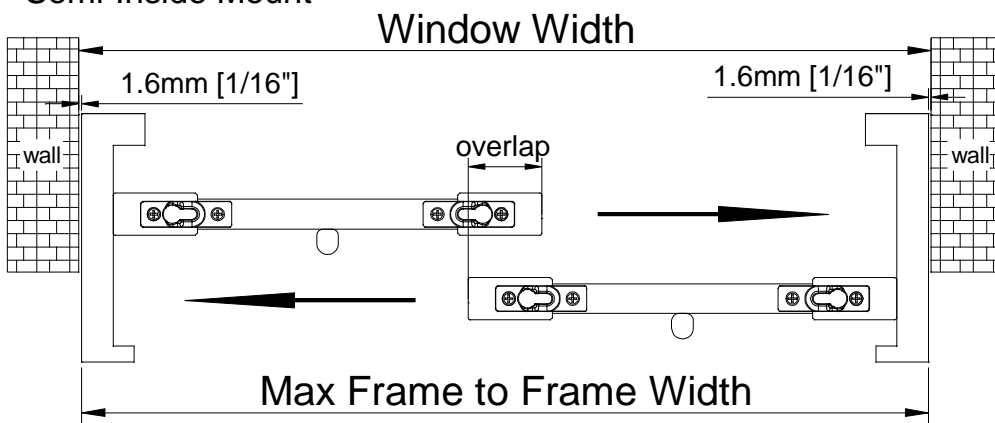

Inside Mount

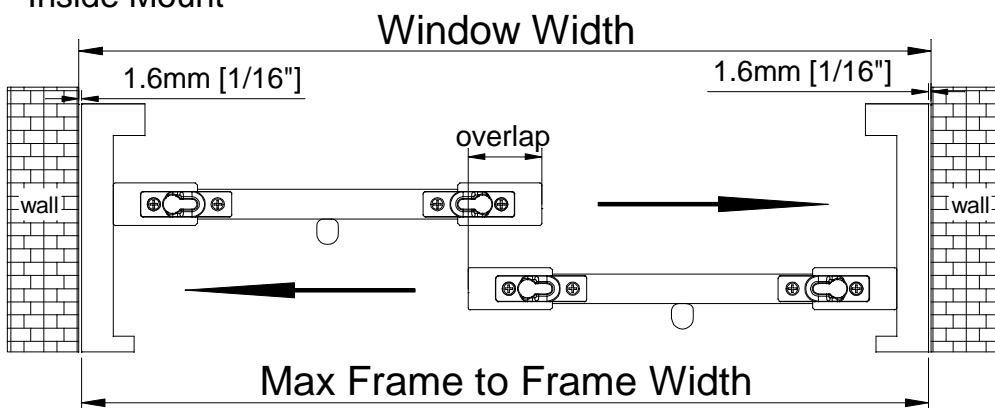

Blindtex Custom Shutter Specification

2020 Bypass

For Non-Ultra Program

4 panels side open w/Rabbit stile with combined Joint

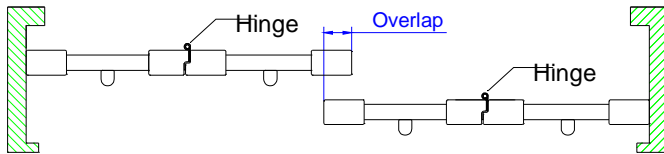

4 panels center open

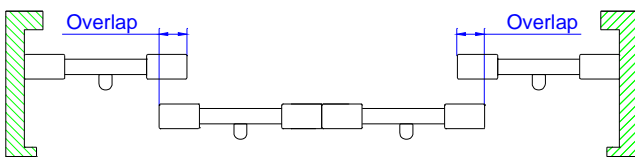

6 panels side open w/Rabbit stile with combined joint

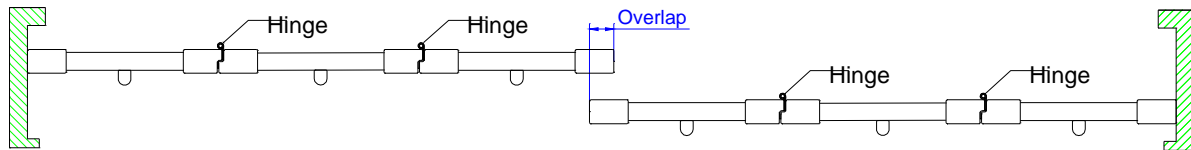

6 panels center open w/Rabbit stile without combined Joint selected

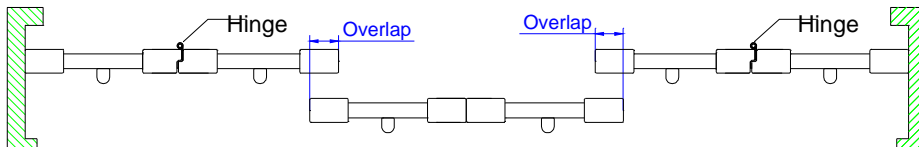

6 panels center open w/Rabbit stile with combined Joint selected

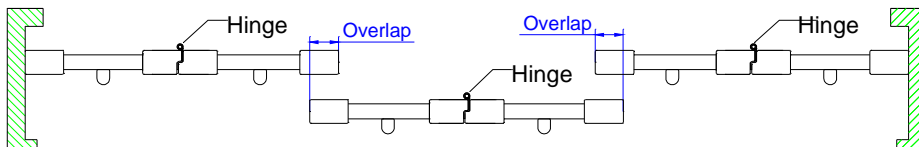

Notes:

The stile between hinged panels is 41.3mm stile except Waterproof E-wood+.

The stile between hinged panels is 50.8mm stile for Waterproof E-wood+.

The stile between hinged panels is butt stile or rabbit stile as per ordered, and default butt stile between non-hinged panels.

Blindtex Custom Shutter Specification

2020 Bypass

For Ultra program:

3 Panel Center Open-Front

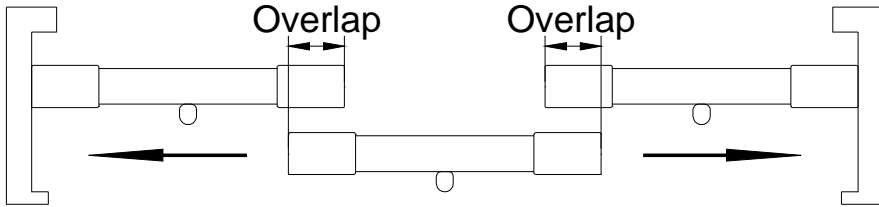

3 Panel Center Open-Back

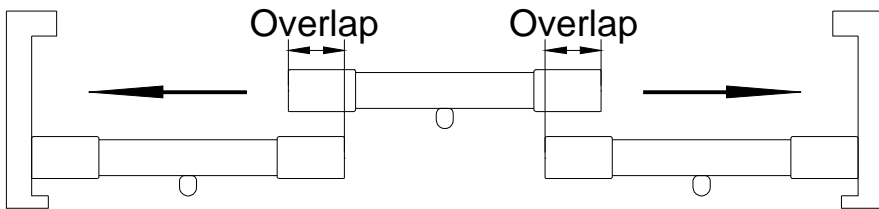

4 Panel Center Open-Front

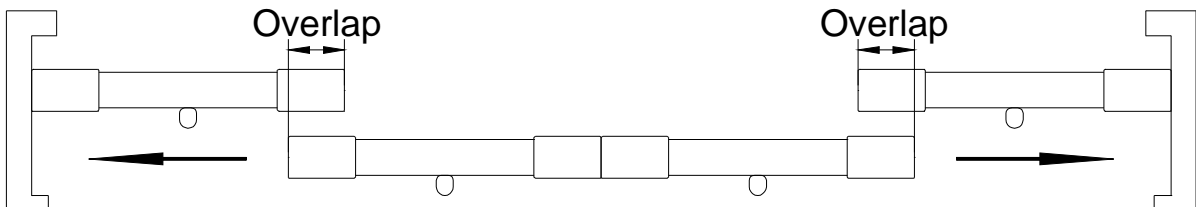

4 Panel Center Open-Back

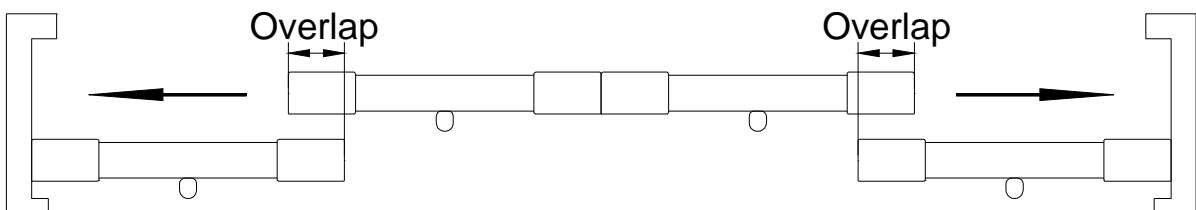

Note: Combined Joint panels are not available.
Three tracks are not available for Ultra program.

Blindtex Custom Shutter Specification

2020 Bypass

Mounting Options (Closed Bypass)

Side View

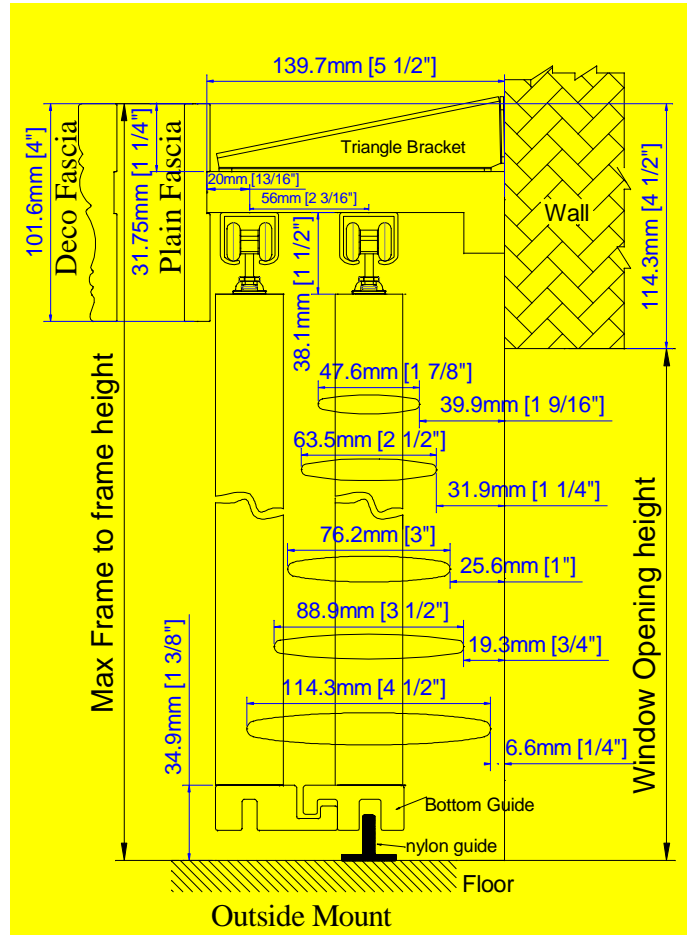
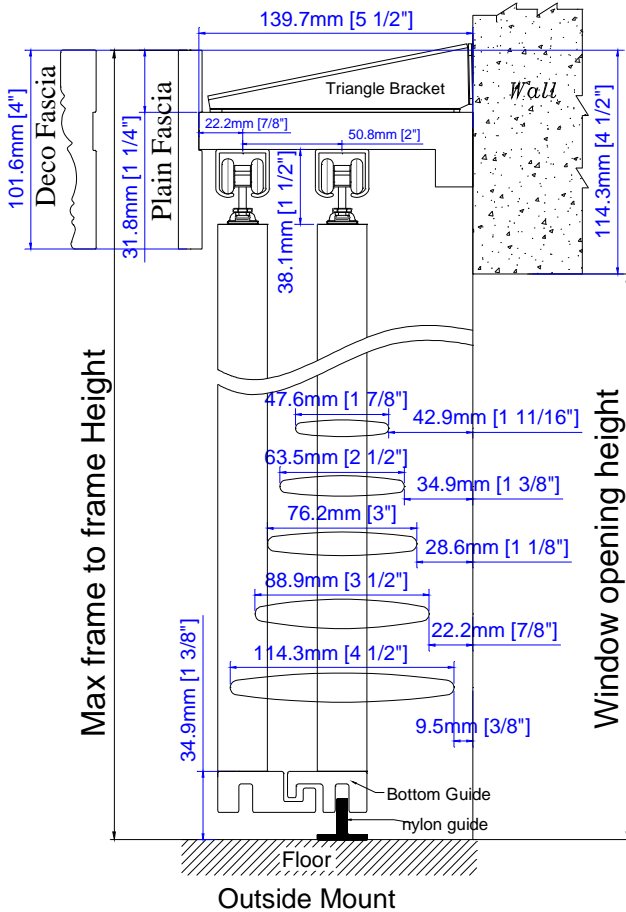

The pitch of top tracks is 50.8mm for Non-Ultra Program and 56mm for Ultra Program.

Bottom Guide

For Wood and Waterproof E-Wood+

For MDF

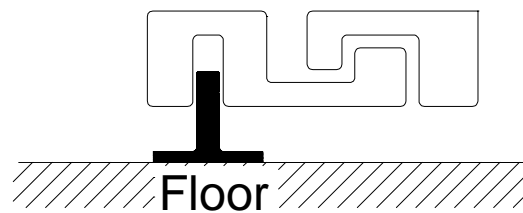
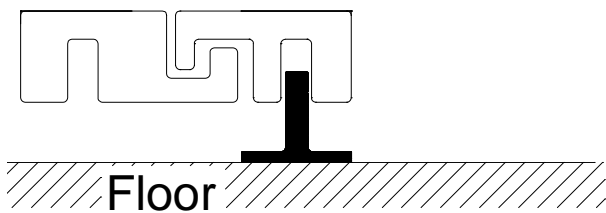

Blindtex Custom Shutter Specification

2020 Bypass

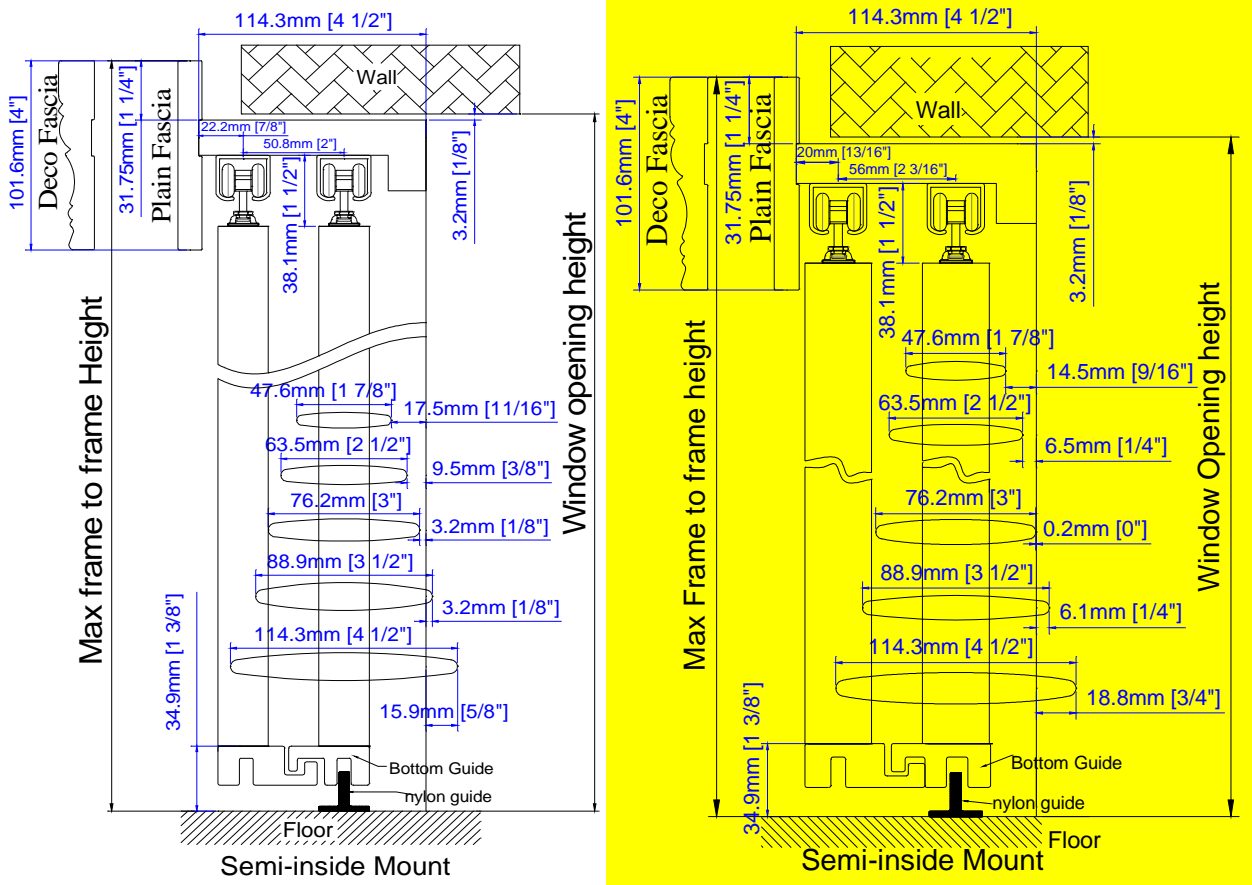

The pitch of top tracks is 50.8mm for Non-Ultra Program and 56mm for Ultra Program.

Blindtex Custom Shutter Specification

2020 Bypass

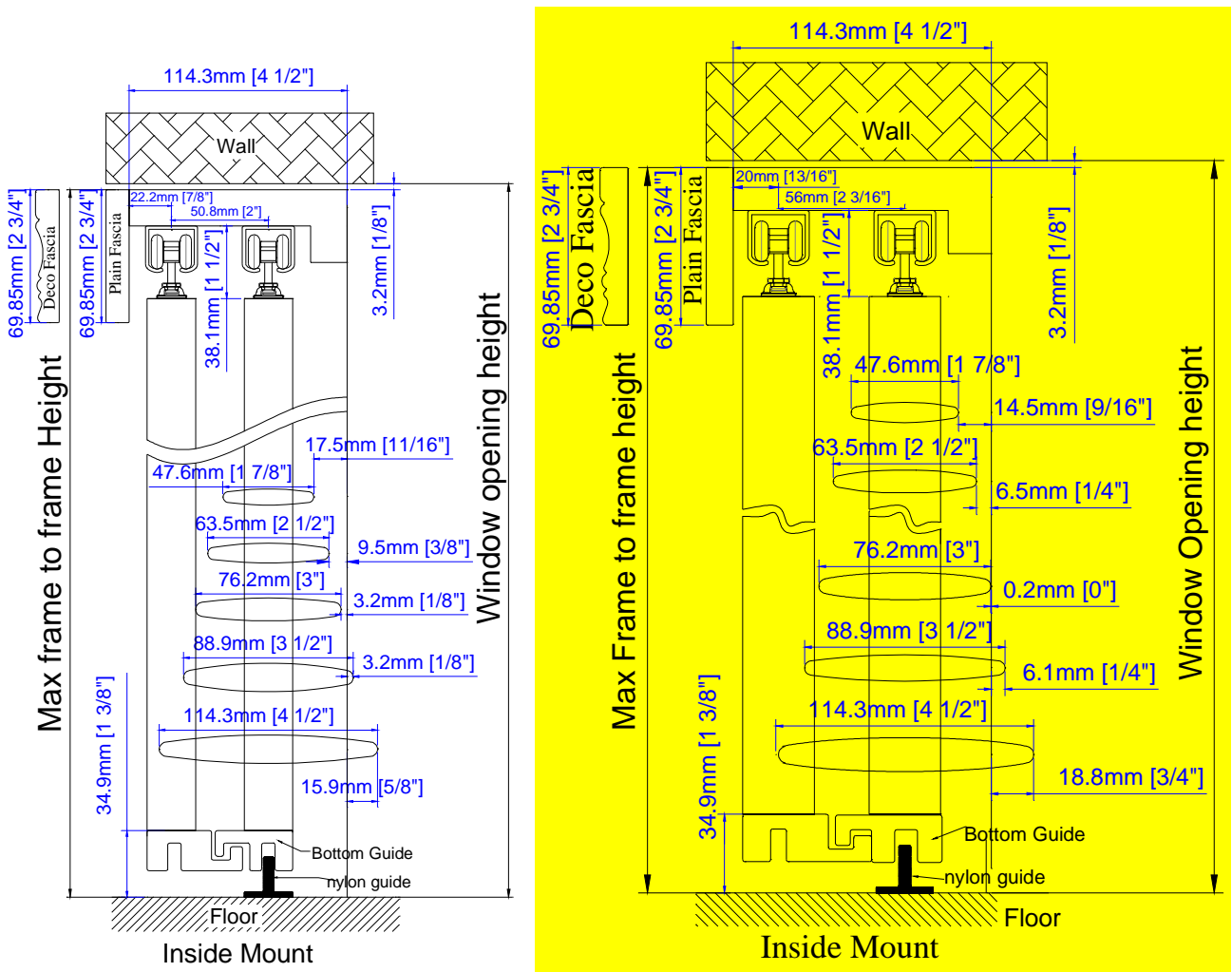

The pitch of top tracks is 50.8mm for Non-Ultra Program and 56mm for Ultra Program.

Blindtex Custom Shutter Specification

2020 Bypass

Mounting Options (Closed Bypass with 3 Tracks): Not available for Ultra program

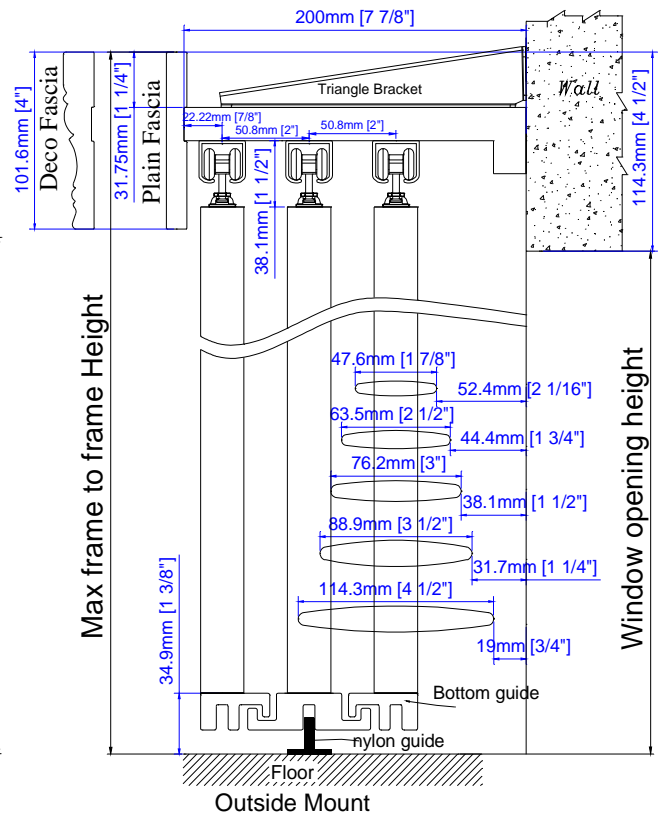
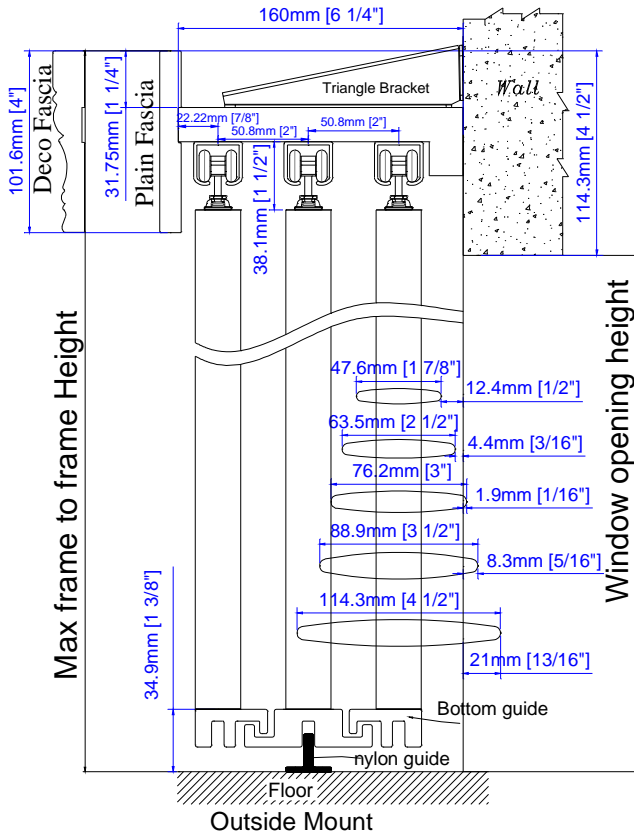

Blindtex Custom Shutter Specification

2020 Bypass

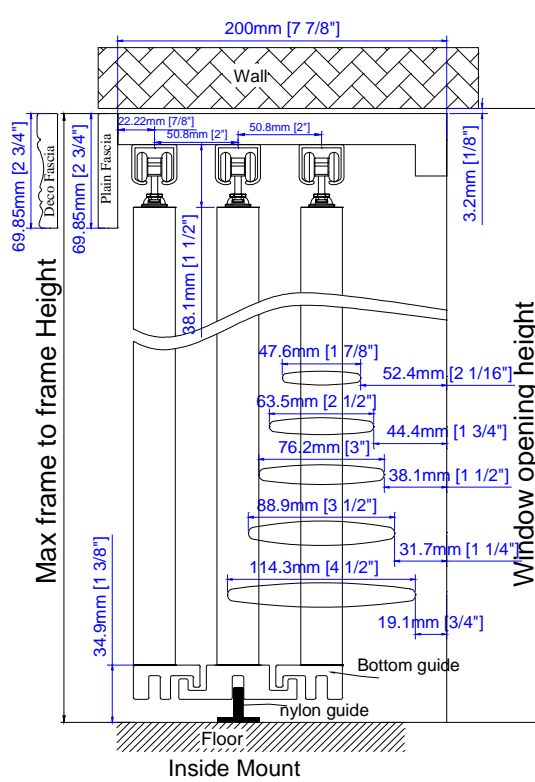
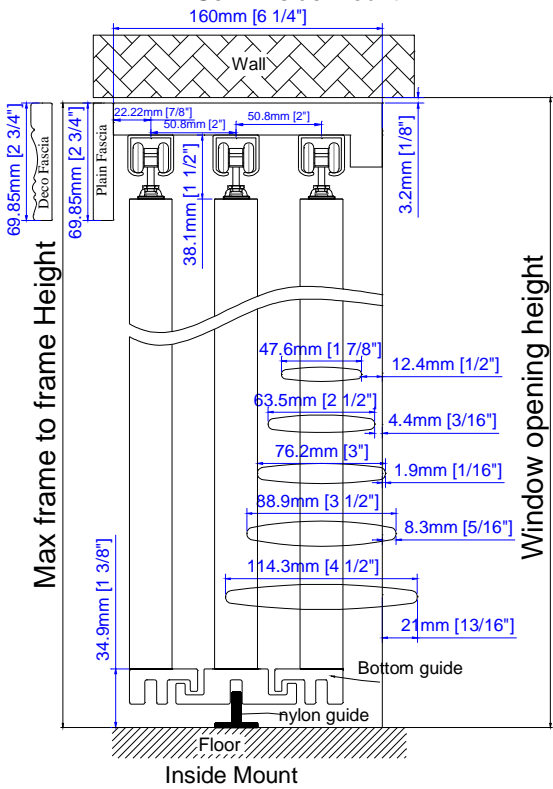
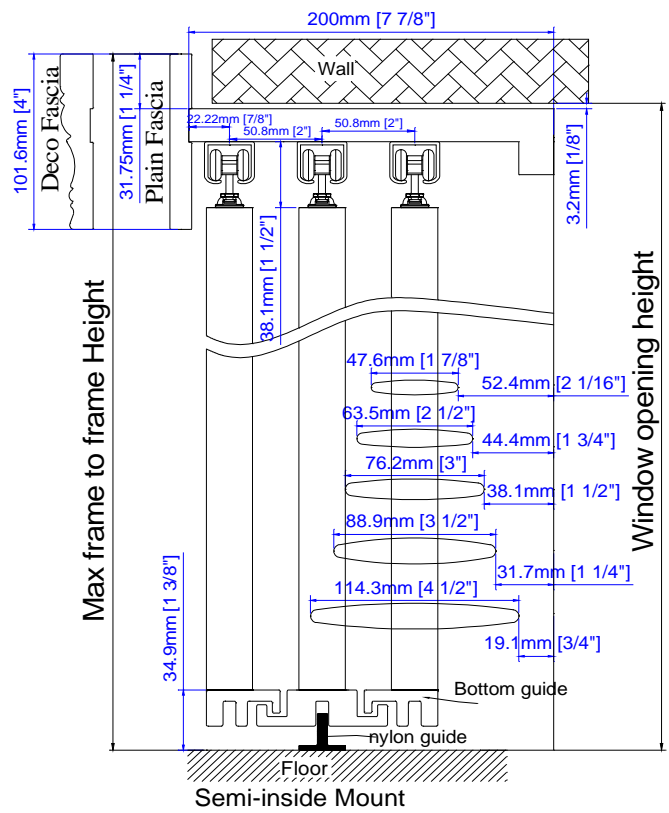
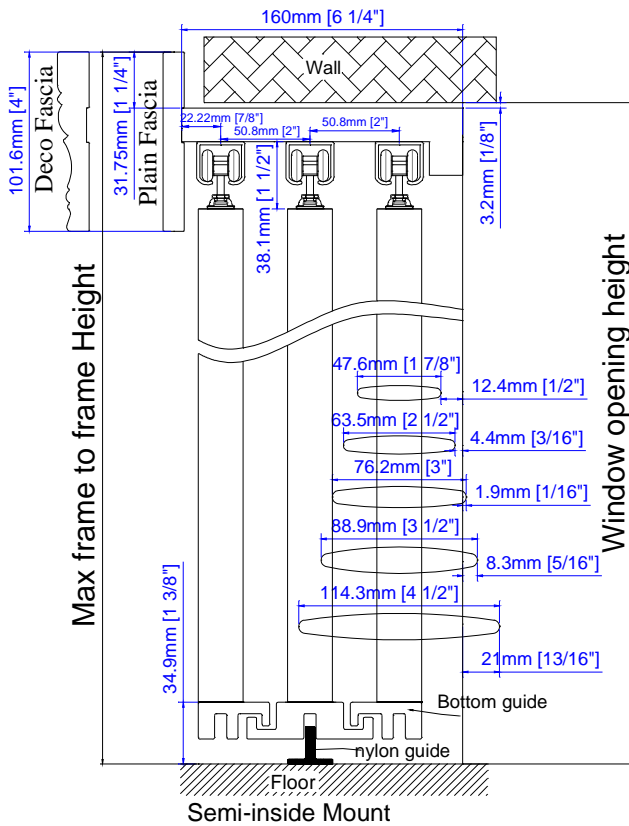

Blindtex Custom Shutter Specification

2020 Bypass

Mounting Options (Opened Bypass): Only available in 63mm and 76mm and 89mm louvers.

63mm Louver

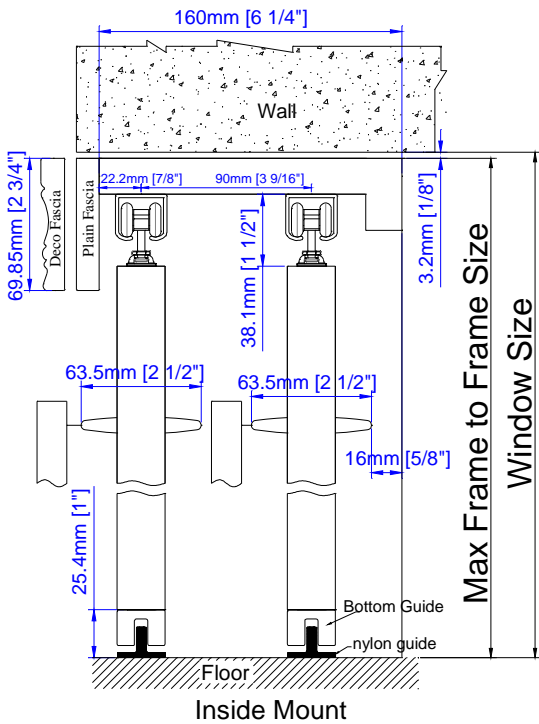
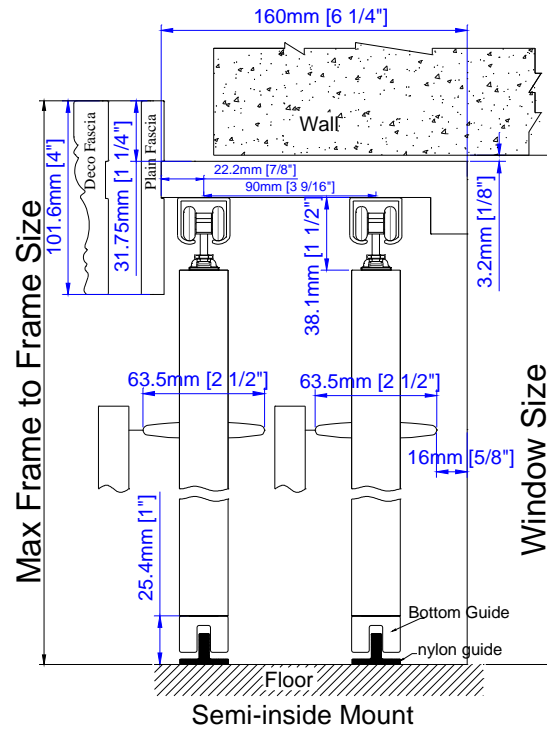
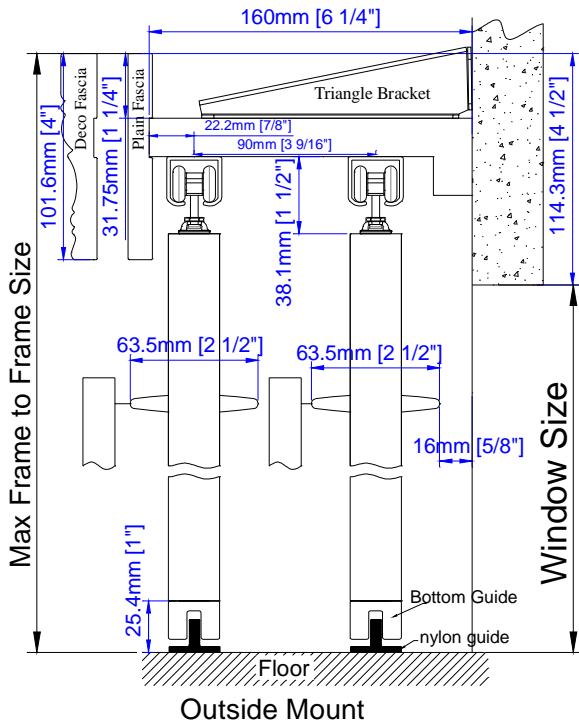

Blindtex Custom Shutter Specification

2020 Bypass

Mounting Options (Opened Bypass) 76mm / 89mm Louver

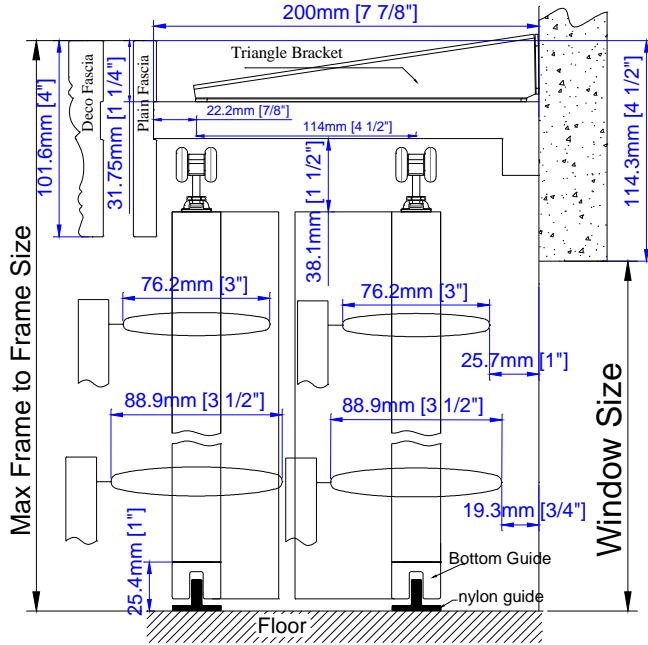

Outside Mount

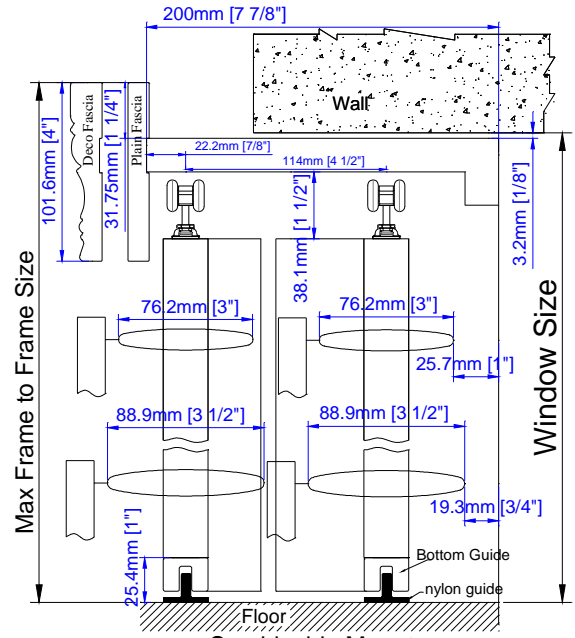

Semi-inside Mount

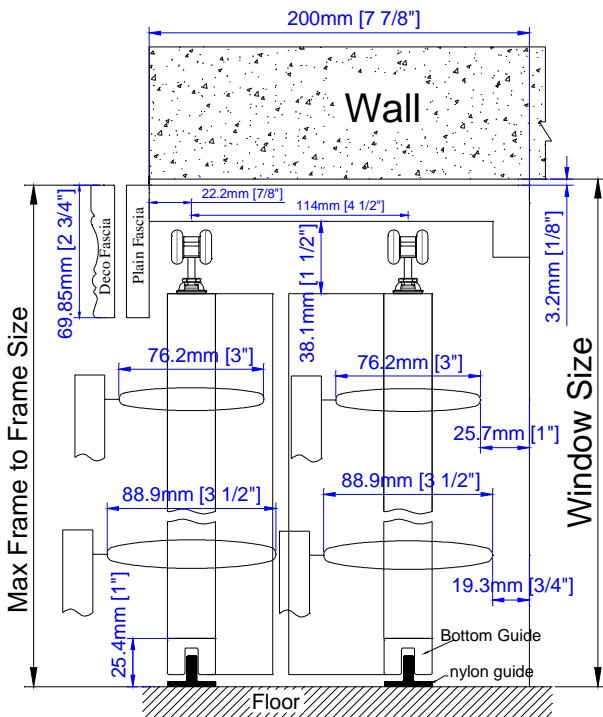

Inside Mount

Blindtex Custom Shutter Specification

2020 Bypass

Bottom Guide for Open ByPass: Default Bottom Guide

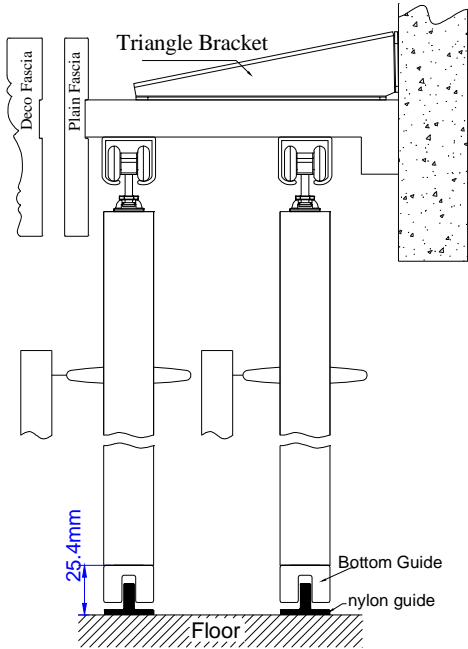

Default Bottom Guide

Optional Interlocking Bottom Guide

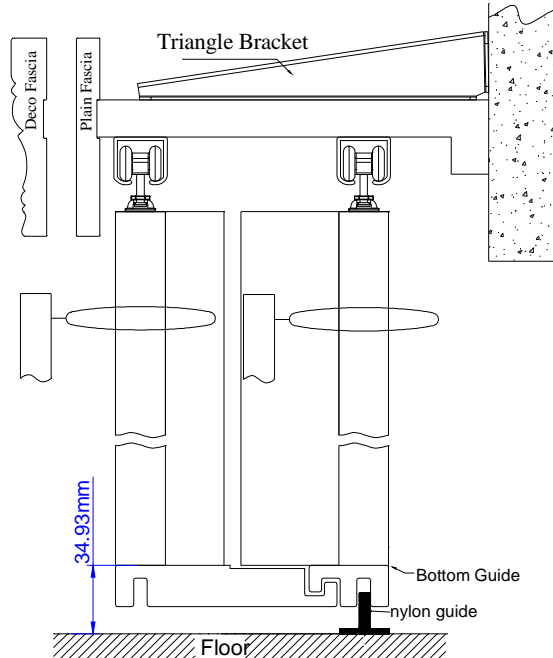

Optional Interlocking Bottom Guide

Bypass with U Bottom Track:

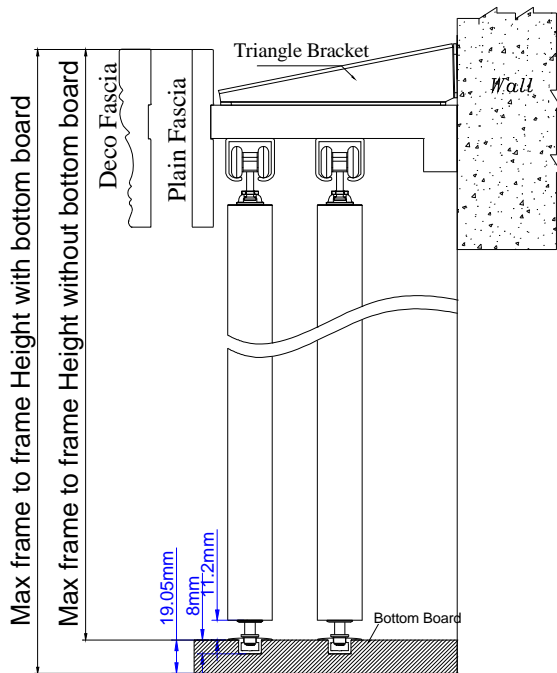

Max frame to frame Height with bottom board

Max frame to frame Height without bottom board

Bypass with M Bottom Track:

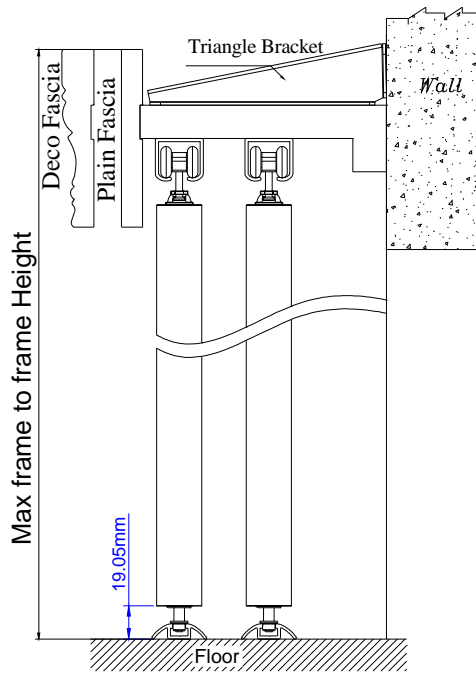

Max frame to frame Height

Blindtex Custom Shutter Specification

2020 Bypass

Opened Bypass

Top View

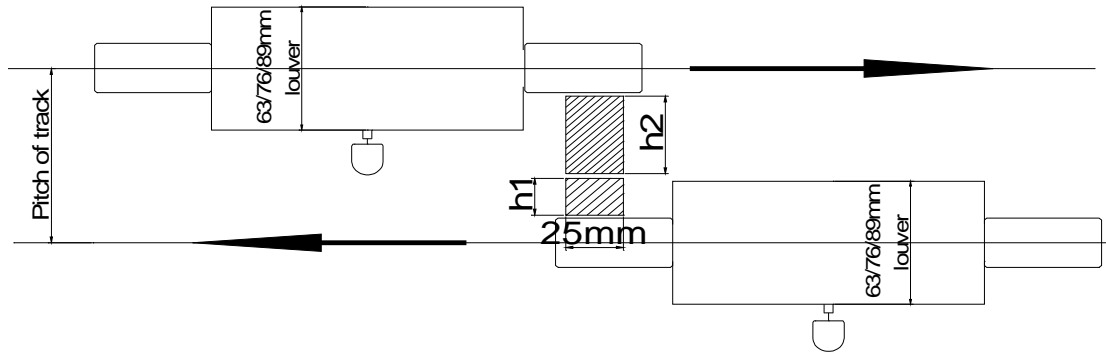

Clearance:

	Top Frame Size (mm)	Louver Size(mm)	Clearance(mm) for Non-Ultra program	Clearance(mm) for Ultra program
Closed Bypass	139.7	47.6	42.9	39.9
		63.5	34.9	31.9
		76.2	28.6	25.6
		88.9	22.2	19.3
		114.3	9.5	6.6
	114.3	47.6	17.5	14.5
		63.5	9.5	6.5
		76.2	3.2	0.2
		88.9	-3.2	-6.1
		114.3	-15.9	-18.8
Closed Bypass with 3 Tracks	160	47.6	12.4	
		63.5	4.4	
		76.2	-1.9	
		88.9	-8.3	
		114.3	-21.0	
	200	47.6	52.4	
		63.5	44.4	
		76.2	38.1	
		88.9	31.7	
		114.3	19.1	

Blindtex Custom Shutter Specification

2020 Bypass

Open Bypass With U-shape bottom guide or U/M-shape bottom track, Standard tilt rod	Top Frame Size (mm)	Louver Size(mm)	Clearance(mm)	Clearance(mm)
	160	63.5	16.0	16.0
	200	76.2	25.7	25.7
	200	88.9	19.3	19.3
Open Bypass With U-shape bottom guide or bottom track, Easy tilt	Top Frame Size (mm)	Louver Size(mm)	Clearance(mm)	Clearance(mm)
	160	63.5	36	39
	200	76.2	47.7	39.7
	200	88.9	41.3	33.3
Open Bypass With S+E bottom guide	Top Frame Size (mm)	Louver Size(mm)	Clearance(mm)	Clearance(mm)
	160	63.5	16	16
	200	76.2	25.7	25.7
	200	88.9	19.3	19.3

Pitch of track for Non-Ultra program:

Louver	U shape bottom guide or U/M-shape bottom track		Interlocking bottom guide	
	Standard Tilt Rod	Easy Tilt	Standard Tilt Rod	Easy Tilt
63mm	90mm	70mm	90mm	90mm
76mm/89mm	114mm	92mm	114mm	114mm

Pitch of track for Ultra program:

Louver	U shape bottom guide or U/M-shape bottom track		Interlocking bottom guide	
	Standard Tilt Rod	Easy Tilt	Standard Tilt Rod	Easy Tilt
63mm	90mm	67mm	90mm	90mm
76mm/89mm	114mm	100mm	114mm	114mm

Light block thickness of panels for Non-Ultra program:

Louver	U shape bottom guide or U/M-shape bottom track		Interlocking bottom guide			
	Standard Tilt Rod	Easy Tilt	Standard Tilt Rod	Easy Tilt		
	All	All	All	Wood	MDF & MDF+ & Waterproof MDF+	
63mm	h1	19mm	19mm	19mm	19mm	40mm
	h2	40mm	19mm	40mm	40mm	19mm
76mm/89mm	h1	30mm	30mm	30mm	30mm	50mm
	h2	50mm	30mm	50mm	50mm	30mm

Light block thickness of panels for Ultra program:

Louver	U shape bottom guide or U/M-shape bottom track	Interlocking bottom guide
--------	---	---------------------------

Blindtex Custom Shutter Specification

2020 Bypass

		Standard Tilt Rod	Easy Tilt	Standard Tilt Rod	Easy Tilt
63mm	h1	14mm	14mm	14mm	
	h2	40mm	14mm	40mm	
76mm/89mm	h1	25mm	30mm	25mm	
	h2	50mm	30mm	50mm	

Track Dimension:

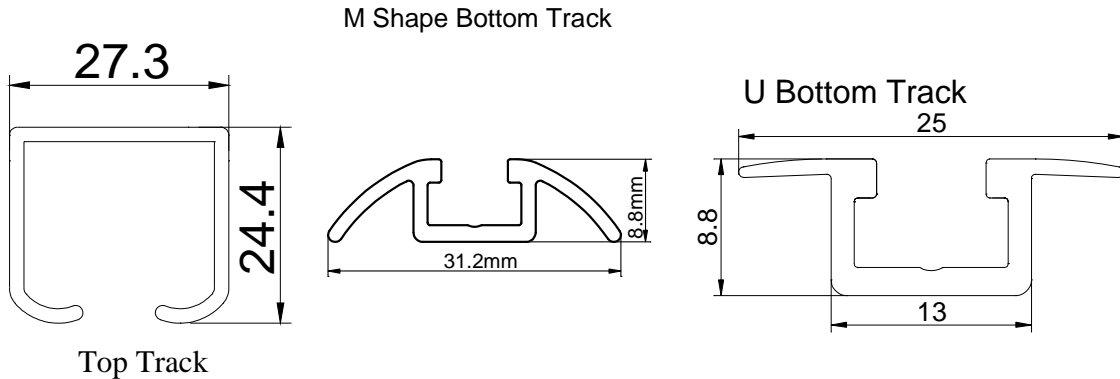

Note: If apply to U shape bottom track, the bottom board should be needed otherwise the customer need slot the floor to install the bottom track. Bottom Board width will be default same as the width of the U shape side frame.

End Caps will be supplied for M shape bottom track for outside / semi-inside mount without side boards:

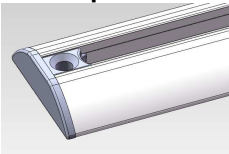

Nylon Guide: The nylon guide is composed by 2 parts and will supplied as a whole set by default (bottom part 16mm and top part 5mm), please remove the top part if necessary.

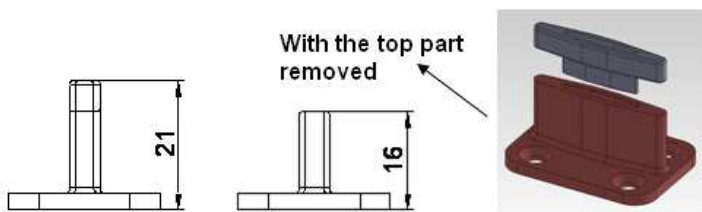

Deduction for U Shape Bottom Track: only available for full recess.

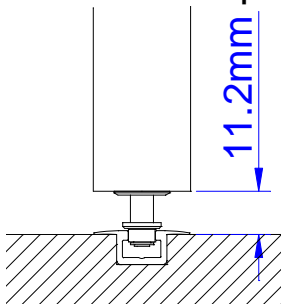

Blindtex Custom Shutter Specification

2020 Bypass

Track Shutters Framing Materials (For waterproof ABS, only plain fascia is available)

Note: For U shape bottom track with bottom board, the bottom board depth is 19mm and width will match with the total width of U shape side frame if the shutter is with side frames required, and it will be default same as the width of the top header frame if the shutter is no side frames

Framing	Size				Pc(s)
L Shape Header	Header (Closed Bypass)	Header (Opened Bypass)	Supporting Strip		
(2 in 1)	19mm x 139.7mm (Default for Outside Mount; Optional for Semi-Inside and Inside Mount)	19mm x 160mm (63mm Louver)	19mm x 19mm		1 pc
Header with Supporting Strip	19mm x 114.3mm (Default for Semi-Inside and Inside Mount; Optional for Outside Mount)	19mmx 200mm (76mm / 89mm Louver)			
	Custom * ≤ 200mm	Custom * ≤ 200mm			
U Shape Side Frame	Side Frame (Closed Bypass)	Side Frame (Opened Bypass)	Supportin g Strip	Side Fascia	Pc(s)
(3 in 1)	19mm x 149.2mm (Default for Outside Mount; Optional for Semi-Inside and Inside Mount)	19mm x 169.5mm (63mm Louver)	19mmx 19mm	9.5mm x 31.8mm	2 pcs
Side Frame with Supporting Strip & Side Fascia	19mm x 123.8mm (Default for Semi-Inside and Inside Mount; Optional for Outside Mount)	19mm x 209.5mm (76mm / 89mm Louver)			
	Custom * ≤ 200mm	Custom * ≤ 200mm			
Top Fascia (Plain/Deco)	101.6mm (Semi-inside and Outside Mount)				1 pc
	69.9mm (Plain) (Inside Mount) 69.9mm (Deco) (Inside Mount)				
Top Fascia Return	101.6mm(Semi-inside and Outside Mount)				2 pcs
	N/A (Inside Mount)				

Blindtex Custom Shutter Specification

2020 Bypass

Note:

- When the header size is 114.3mm, 139.7mm, 160mm or 200mm, the L Shape header and the U Shape Side Frame will be sent integrally. That is:
 1. The header and the supporting strip will be sent integrally as L Shape Header;
 2. The side frame, supporting strip and the side fascia will be sent integrally as U Shape Side Frame.
- For any custom header sizes other than 114.3mm, 139.7mm, 160mm or 200mm, the L Shape Header and the U Shape Side Frame will be sent separately. That is:
 1. The header and the supporting strip will be sent separately for L Shape Header;
 2. The side frame, supporting strip and the side fascia will be sent separately for U Shape Side Frame.

Hardware Box:

Hardware Box
Part
Wrench
Nylon Guide
19mm screws for Nylon Guide
Triangle Bracket (based on the length of header)
50.8mm screws for Triangle bracket
19mm screws for Triangle bracket

The 2020 Stopper

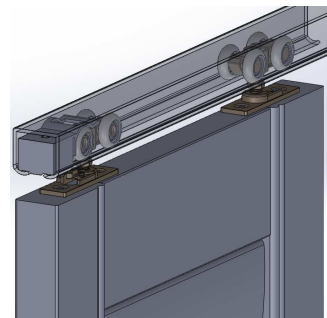
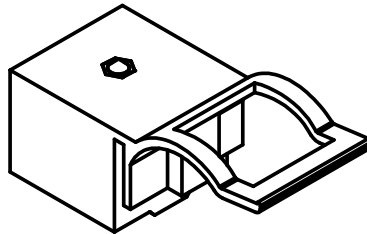
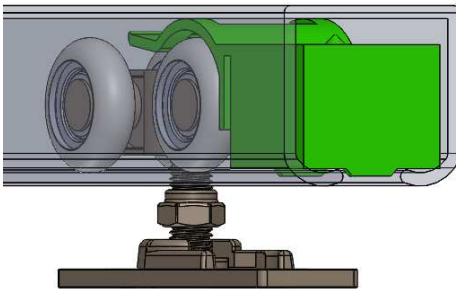

Note: 2020 Stopper will be supplied at both ends of top track by default.

The 2020 stopper can also be used in the center or any position of the top track as an option. Please specify the actual position when placing an order.

Blindtex Custom Shutter Specification

2020 Bypass

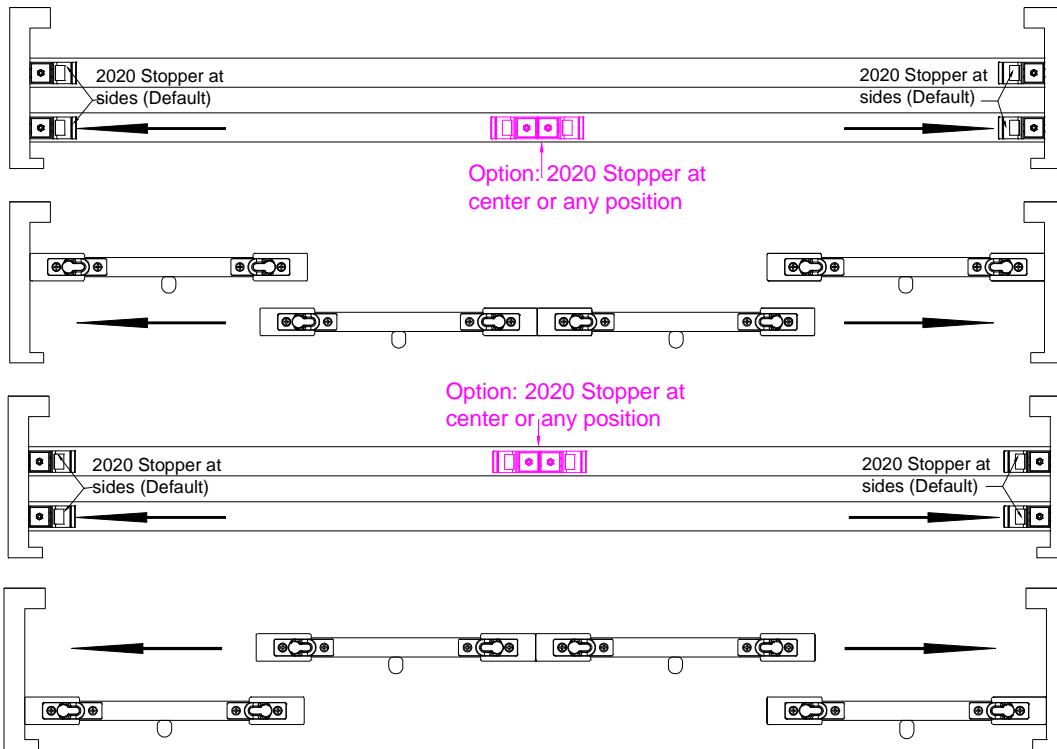

Plastic L Bracket to Connect the Header, Fascia & Fascia Returns



L Bracket will be used to connect the header, fascia and fascia returns for Bypass shutter. This applies for Inside Mount, Semi-Inside Mount & Outside Mount.

OM & Semi-IM

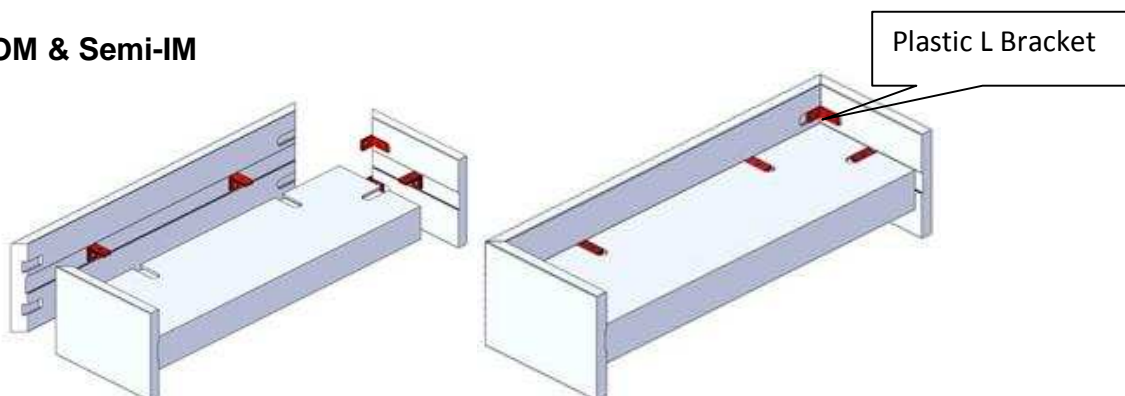

Blindtex Custom Shutter Specification

2020 Bypass

IM

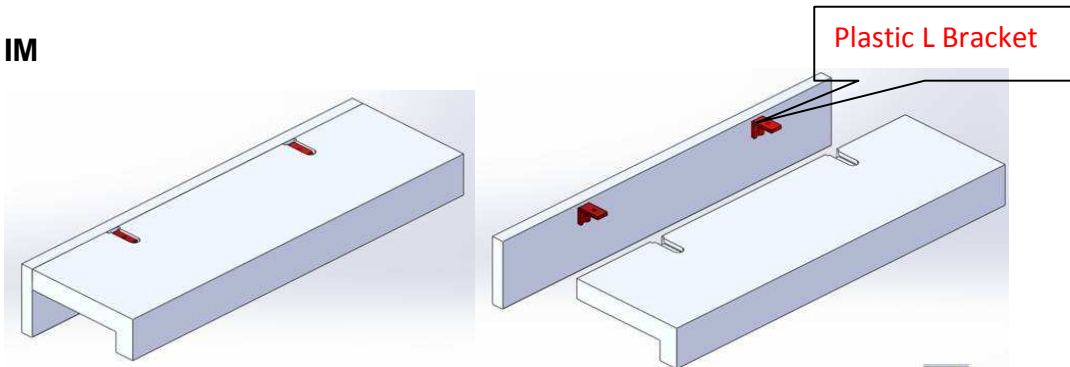

Keystone for Fascia of the Track Shutter

When fascia length exceeds the limitation and needs to split, keystone design fascia will be supplied as an option without surcharge for track shutters.

For fascia length within the split limitation, keystone can also be supplied as an option with surcharge.

For Deco Fascia:

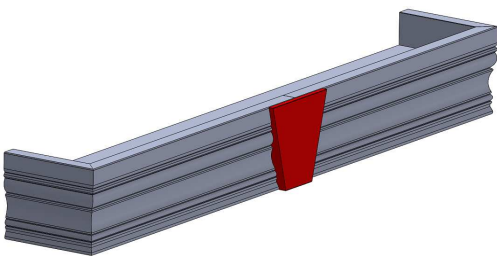

For Plain Fascia:

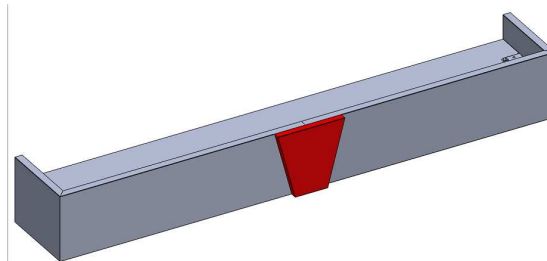

The keystone will be installed by screws. We will pre-drill the screw holes and the screws will be packed in hardware box.

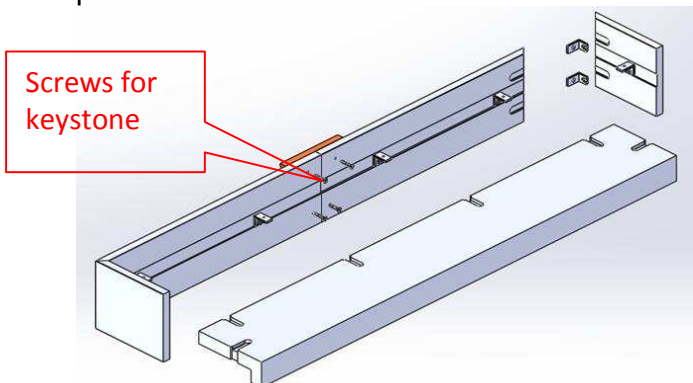

Blindtex Custom Shutter Specification

2020 Bypass

The Claim Limitation Date for Shipping Damage for Airfreight Orders:

For all airfreight orders with shipping damages, claims must be submitted within 1 week after the date of receipt.

Color coordination chart:

No.		Color ID	Color Name	New Top & Bottom Tracks color (Default)
1	Paint (36 colors)	001	Pure White	Bright White
2		002	Extra White	Bright White
3		003	Silk White	Bright White
4		004	Bright White	Bright White
5		006	Pearl	Bright White
6		007	Ivory Lace	Metallic Gray
7		009	Creamy	Bright White
8		011	Cameo	Metallic Gray
9		012	Crisp Linen	Metallic Gray
10		013	Bisque	Metallic Gray
11		014	Alabaster	Metallic Gray
12		016	Butter	Metallic Gray
13		019	String	Bronze
14		030	Moondust	Metallic Gray
15		032	Sea Mist	Metallic Gray
16		042	Hall Gray	Metallic Gray
17		045	Elephants Air	Metallic Gray
18		046	Ice	Bright White
19		048	Chai	Bronze
20		049	Stone Gray	Bronze
21		051	Brown Gray	Bronze
22		053	Clay	Bronze
23		054	Frost	Bright White
24		059	Silverleaf	Metallic Gray
25		063	Decorators White	Bright White
26		066	Winchester White 2010	Metallic Gray
27		072	Mattingley 267	Metallic Gray
28		073	Sky Gray	Bright White
29		074	Element Gray	Metallic Gray
30		075	Storm Gray	Metallic Gray
31		076	Aura White	Bright White

Blindtex Custom Shutter Specification

2020 Bypass

32	Stain (32 colors)	077	Dawn	Metallic Gray
33		078	Cloud Blue	Metallic Gray
34		079	Chalk Pink	Bright White
35		080	Taupe Gray	Metallic Gray
36		836	Classic Black	Bronze
37		108	Rustic Gray	Bronze
38		109	Weathered Teak	Bronze
39		110	Limed White	Bronze
40		111	Pebble	Metallic Gray
41		114	Taupe	Bronze
42		200	Natural	Bronze
43		202	Golden Oak	Bronze
44		204	Oak Mantel	Bronze
45		205	Goldenrod	Bronze
46		211	Cherry	Bronze
47		212	Dark Teak	Bronze
48		215	Cordovan	Bronze
49		219	Mahogany	Bronze
50		220	New Ebony	Bronze
51		221	Black Walnut	Bronze
52		227	Red Oak	Bronze
53		229	Rich Walnut	Bronze
54		230	Old Teak	Bronze
55		231	Spring Rose	Bronze
56		232	Red Mahogany	Bronze
57		233	Dark Mahogany	Bronze
58		237	Wenge	Bronze
59		242	Auburn	Bronze
60		246	Matte Black	Bronze
61		248	Pretzel	Bronze
62		249	Acorn	Bronze
63		250	Sumatra	Bronze
64	252	Toffee	Bronze	
65	254	Driftwood	Metallic Gray	
66	255	Silver Gray	Metallic Gray	
67	256	Mist	Metallic Gray	
68	862	French Oak	Bronze	

Blindtex Custom Shutter Specification

2020 Bypass

Note: When the bottom track colors are bright white and metallic gray, the default spring loaded guide color will be white;

When the bottom track color is bronze, the default spring loaded guide color will be coffee.